

**PIENAAR ENERGY (PTY) LTD**

# **Can solar power generators be used at home at night**



## Overview

---

A solar generator can be an excellent choice for powering your home during a power outage. To make sure your solar generator is able to run at night, you will need to purchase. As more homeowners and outdoor enthusiasts adopt solar energy solutions, a common question arises: do solar generators work at night?

Since these devices rely on sunlight for charging, it's natural to wonder what happens when the sun goes down. In this article, we'll explore how solar generators. Yes, solar generators do work at night. While solar generators aren't able to charge themselves back up with solar panels at night to replenish the energy used, all the energy stored in them is still readily available to use at night. If you're relying solely on solar panels, darkness means zero energy production.

## Can solar power generators be used at home at night



### Do Solar Generators Work at Night: (This Is How They Do!)

Yes, solar generators do work at night. While solar generators aren't able to charge themselves back up with solar panels at night to replenish the energy used, all the energy stored in them is still readily ...

[Get Price](#)

### How Do Solar Generators Work at Night and During Cloudy Days?

Solar generators do not produce new energy at night but can still provide power through stored energy. During the day, excess energy is stored in the generator's battery system. This stored energy is ...

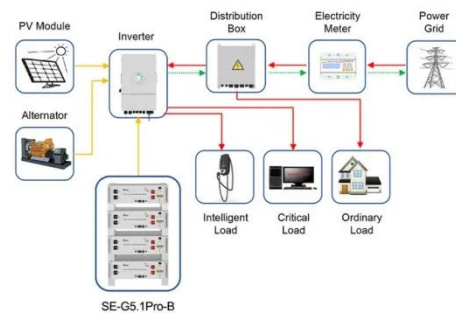



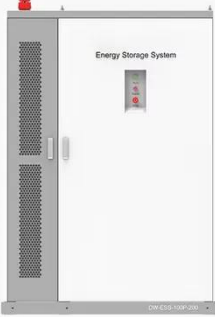

Application scenarios of energy storage battery products

[Get Price](#)

**◆ PRODUCT INFORMATION ◆**



-  BATTERY CAPACITY  
50kWh-500kWh
-  DC VOLTAGE RANGE  
400V-1000V
-  DEGREE OF PROTECTION  
IP54
-  OPERATING TEMPERATURE RANGE  
-10-50°C

### Do Solar Generators Work at Night? Facts You

Solar generators rely on photovoltaic cells to convert sunlight into electrical energy. These cells do not work at night, so solar generators are not able to produce electricity during nighttime hours. However, ...

[Get Price](#)

## Do solar generators work at night?

In essence, solar generators don't need the sun to work at night--they need fully charged batteries. With the right setup and daytime charging routine, these devices can easily provide uninterrupted power through the ...

[Get Price](#)



## Do Solar Power Generators Work At Night?

Solar panels rely on direct sunlight to generate electricity. At night, the absence of sunlight means that photovoltaic cells cannot capture photons, and thus, no electricity is produced.

[Get Price](#)

## Solar Generator

The ability to use solar-generated power at night depends on the capacity of the battery storage system and the amount of energy stored during daylight hours. The larger the battery capacity, the more energy can be ...

[Get Price](#)



## Can I Use a Solar Generator at Night?

Technically, no. Solar generators cannot

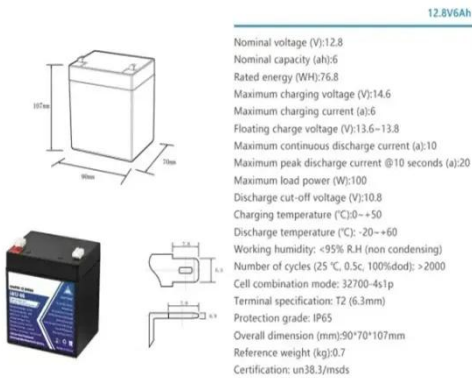

generate energy at night because the photovoltaic cells in solar panels need light to create electricity. However, solar generators can produce energy at night in a couple of indirect ...

[Get Price](#)

## Do Solar Generators Work At Night?

Solar generators are increasingly popular as a sustainable and eco-friendly power solution, especially for off-grid living, emergency backup, and outdoor adventures. However, a common question ...

[Get Price](#)

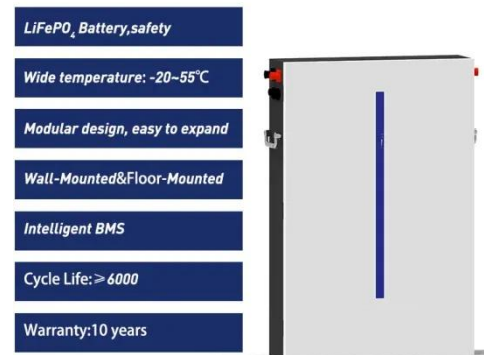

## Do Solar Generators Work at Night?

No, solar generators do not work at night--unless they have a battery storage system. If you're relying solely on solar panels, darkness means zero energy production.

[Get Price](#)

## How Do Solar Generators Work At Night 2025: Complete Guide

Discover how solar generators provide power at night through battery storage

systems. Learn about capacity, efficiency, and real-world applications for reliable nighttime solar power.

[Get Price](#)



---

## Contact Us

---

For catalog requests, pricing, or partnerships, please visit:  
<https://www.pienaarshof.co.za>

